



N-TYPE

METAL



ELECTRONS 

CONDUCTION

FREE ELECTRON ENERGY LEVEL

VALENCE

COVER: ENERGY DIAGRAM FOR SCHOTTKY BARRIER

SEE:

USING HOT CARRIER DIODES AS DETECTORS, P. 2

NOTE ON HOT CARRIER DIODES, P. 3

USING HOT CARRIER DIODES AS MIXERS, P. 6

USING THE HOT CARRIER DIODE AS A DETECTOR

WITH RESPECT to conventional devices, hot carrier diodes in detector application have several advantages. Having lower noise and better conversion efficiency, they are more sensitive, especially for low video frequency operation. Low reverse leakage current and nearly ideal diode characteristics permit precise analytic circuit design and provide wider dynamic range. Uniformity and stability insure the reproducibility and longevity of circuit performance. These electrical advantages apply in the RF spectrum extending well beyond S-band and, for some applications, beyond X-band. Moreover, their electrical and mechanical ruggedness enhance their desirability in situations requiring high performance and long life in severe environments.

In detector applications there are several criteria to be considered:

- (1) Sensitivity, comprising:
 - (a) conversion (rectification) efficiency
 - (b) bandwidth (RF and video)
 - (c) dynamic resistance
 - (d) noise properties
- (2) Square-law range
- (3) Burnout energy

It has been industry practice to *measure* rather than *analyze* and evaluate sensitivity, specifying only a particular set of measurement conditions. With the ideality of a Schottky barrier diode, however, this experimental approach is unnecessary, because performance under any conditions can be precisely evaluated and optimized analytically, as discussed in this article.

SENSITIVITY

Consider first the conversion effi-

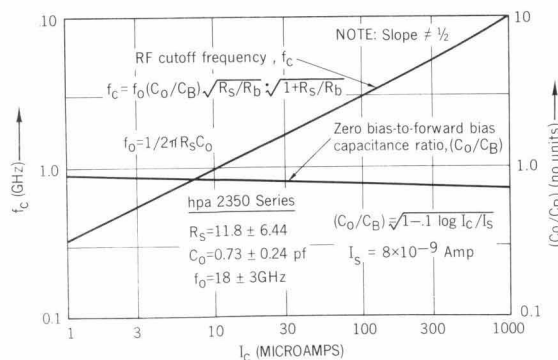

Fig. 1. RF cutoff frequency of diode conversion efficiency and variation of Schottky barrier capacitance ratio with diode bias current.

THE 'HOT CARRIER' DIODE AS AN ULTRA-FAST DETECTOR, MIXER, AND SWITCH

The 'hot carrier' diode is a new semiconductor rectifying device that offers a number of advantages over p-n junctions or point contact diodes. Compared to p-n junctions the hot carrier diode has a much higher frequency capability; compared to point contact diodes it has improved electrical performance and mechanical ruggedness. It is also important because it has a nearly-ideal diode characteristic; consequently its conversion efficiency in mixer applications is higher than other diodes. Other important properties include a low noise and a large square-law range.

ciency of a diode. Conversion efficiency can be expressed* as:

$$\beta_c = \left\{ \frac{\beta}{2} \left[\frac{1}{1 + \frac{R_s}{R_B}} \right] \right\} \left\{ \frac{1}{1 + \left(\frac{f}{f_c} \right)^2} \right\} \quad (1)$$

where $\beta = \frac{1}{n} \left[\frac{q}{kT} \right]$

and R_s = parasitic series resistance of diode.

DYNAMIC RESISTANCE

The value of R_B can be adjusted with bias current according to the relation:

$$R_B = \frac{1}{\beta I_c} = \text{dynamic resistance of Schottky barrier.} \quad (2)$$

Although the adjustability of R_B is not unique to hot carrier diodes, the use of bias current in other devices yields a

* The expressions given here without proof are developed in the author's original unabridged article; copies available on request.

The metal-on-semiconductor concepts on which the hot carrier diode is based extend back several decades to the work of Schottky, although these concepts were not pursued until recently because of technological limitations. Development work has now been carried out in the light of present technology by **hp associates**, -hp-'s division concerned with semiconductor research, development and manufacturing. A result of this has been that hot carrier diodes have been produced by **hpa** for the last year, the first such diodes commercially available.

The articles by **hpa** engineers in this issue describe the advances in detector and mixer performance possible with these diodes. These articles are condensations of original articles, reprints of which are available on request.

nonlinear relationship and introduces high levels of flicker noise.

RF BANDWIDTH

In equation 1, the second factor describes the RF frequency response, where f_c is the RF cutoff frequency. Since Schottky barrier lifetime is negligible, the cutoff frequency can be analytically expressed as:

$$f_c = \frac{\sqrt{1 + \frac{R_s}{R_B}}}{2\pi C_B \sqrt{R_s R_B}} = \left(\frac{1}{2\pi C_B R_s} \right) \left(\frac{C_o}{C_B} \right) \sqrt{\frac{R_s}{R_B}} \cdot \sqrt{1 + \frac{R_s}{R_B}} \quad (3)$$

where C_B = Schottky barrier capacitance

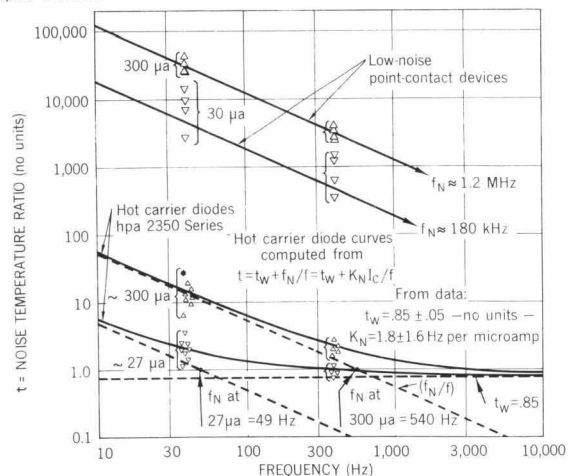
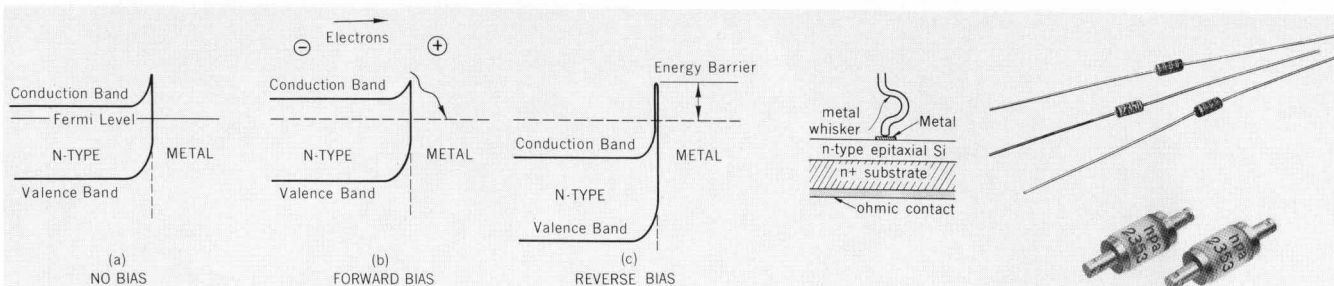

Fig. 2. Spectral density of relative noise power (or "noise temperature ratio") for hot carrier and point contact devices.



HOT CARRIER DIODES

Hot carrier devices are distinguished from the more conventional semiconductor devices in that the junction consists of a metal and a semiconductor rather than two different semiconductors. The junction in hot carrier diodes is made to be rectifying instead of ohmic through choice of materials with suitably-related work functions. In the diodes thus formed, current flow occurs mainly by means of majority carriers (usually electrons in practice rather than holes because of the higher mobility of electrons). When the diode is forward-biased, the majority carriers are injected into the metal at a much higher energy level than the metal's existing free electrons — hence the name 'hot carrier' diodes.

A qualitative description of the operation of the hot carrier diode in comparison with the operation of a p-n junction can be given in terms of the accompanying energy level diagrams.

In the p-n junction it will be recalled that holes are injected from the p to the n side and exist there as minority carriers. Similarly, electrons are injected from the n to the p. Although the existence of these minority carriers is necessary for current to

flow, their presence becomes troublesome when it is desirable to obtain a rapid response in junction conditions to a change or reversal of the bias. If the polarity of the bias is reversed, for example, current will flow easily in the reverse direction until the minority carrier density is reduced either by removal or recombination. The flow of reverse current lowers rectification efficiency if the diode is used as a detector or increases the reverse recovery time if the diode is used as a switch. The time constant for the reduction of the minority carrier density is the lifetime. Much work has been done to minimize lifetimes, but shorter lifetimes are usually obtained at a sacrifice of other desirable qualities.

In the hot carrier diode there exists at the semiconductor-to-metal interface an energy barrier known as the Schottky barrier which occurs because of the difference in the work functions of the two materials. This barrier is decreased by a forward bias and increased by a reverse bias; hence, the barrier results in a rectifying diode. In the forward bias condition the majority carriers (electrons) are injected from the semiconductor into the metal where they initially have an energy level substantially above the metal's free electrons. In the metal the hot electrons give up their excess energy in

a remarkably short time—about 100 femtoseconds (femtosecond = 10^{-15} second) after which they become part of the sea of free electrons in the metal.

The electron flow from semiconductor to metal occurs with virtually no flow of minority carriers in the reverse direction. Consequently, the response to a change in bias in the hot carrier diode is much faster than p-n junctions. Even the slowest hot carrier diodes have lifetimes of less than two hundred picoseconds, while the faster ones have lifetimes too short to be presently measurable. In addition, the low minority carrier density means that there is less stored charge in the junction. This, in turn, reduces the drive requirements when the diode is operated as a switch.

Hot carrier diodes have a larger area contact with larger capacitance than point contact diodes, but they also have the ability to handle greater power and are less sensitive to current transients than point contacts. They are also **mechanically more stable** and have more nearly ideal and **reproducible electrical characteristics**.

Hot carrier diodes are produced by hpa as epitaxial silicon devices using metals on n-type silicon. The construction of the hpa hot carrier diode is shown in the diagram.

and $C_0 =$ barrier capacitance at zero bias.

Although the variation of C_B with bias can be expressed analytically, the relationship is more easily seen in curve form, as given in Fig. 1, with the RF cutoff frequency. This cutoff frequency, with the calculable low-frequency factor, describes the conversion efficiency at any frequency and bias level.

DIODE NOISE

Perhaps the most outstanding feature of the -hpa- hot carrier diode is its low noise. The noise property of any two-terminal device is conveniently represented as the ratio of its available noise power to thermal noise power. This ratio is often called (though somewhat erroneously) the *noise temperature ratio*, t :

$$t = \frac{\text{Available Noise Power}}{(4 kT) (\text{Video Bandwidth})} \quad (4)$$

In situations where the presence of flicker noise is significant, it is ex-

pressed as a component of the noise temperature ratio, according to the relation which may be called either "spectral noise power density ratio" or "spot noise temperature":

$$B \ll f \quad \text{gives Spot Noise Temperature} \\ t(f) = t_w + \frac{f_N}{f} \quad (5)$$

$B =$ Video Bandwidth
 $t_w =$ Fixed Component
 $f_N =$ "Noise Corner"

Then, integrating equation (5) over a band gives the noise temperature ratio for that band, $B = f_2 - f_1$:

$$t_B = t_w + \frac{f_N}{B} \ln \frac{f_2}{f_1} \quad (6)$$

In terms of these definitions the noise properties of the -hpa- 2350 series hot carrier diodes are analyzable. t_w is a constant, while f_N varies jointly as the bias current, according to the relation:

$$f_N = K_N I_c \quad (7)$$

Next applying definitions (5) and (6) we have the full description of the noise property:

$$\begin{cases} t(f) = t_w + \frac{K_N I_c}{f} \\ t_B = t_w + \frac{K_N I_c}{B} \ln \frac{f_2}{f_1} \end{cases} \quad (8)$$

In the -hpa- 2350 series:

$$t_w = .85 \pm .05 \\ K_N = 1.8 \pm 1.6 \text{ Hz per } \mu\text{amp} \\ I_c = \text{Bias Current}$$

A plot of equation (8) for bias currents of 27 μamp and 300 μamp is given in Fig. 2. These curves were constructed using average values of the constants t_w and K_N from a number of diodes, rather than averaging the data and drawing curves to fit. The closeness of the fit is therefore a check on the validity of equation (8) and a testimony to the uniformity of the diode noise properties.

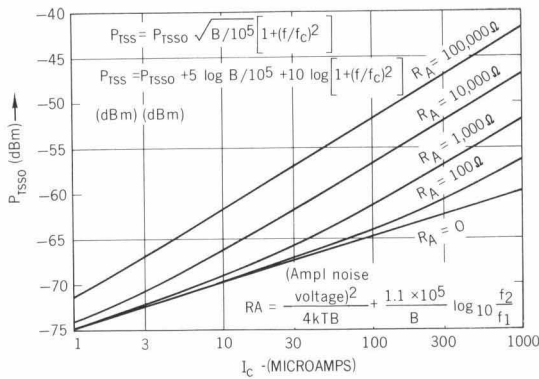

Fig. 3. Low-frequency tangential sensitivity of hot carrier diode detector vs. bias current for various equivalent noise resistances.

Fig. 2 also shows, for comparison, the noise properties, under the same conditions, of low-noise point contact devices. With noise corners 3 to 4 orders of magnitude higher than those of hot carrier diodes, they would introduce significant flicker noise even in a fairly broad bandwidth. In a 10 MHz bandwidth, however, the flicker noise contribution would be negligible. It is for this reason that the 10 MHz "standard" sensitivity specification bandwidth is meaningless with respect to applications involving video bands below 1 MHz.

SYSTEM NOISE

The total noise in a detector system can be expressed as an equivalent noise current at the input, being the vector sum of diode noise current and equivalent amplifier noise current:

$$i_N = \sqrt{i_{N, \text{amp}}^2 + i_{N, \text{diode}}^2} \quad (9)$$

For the *-hpa-* 2350 series, the diode component may be calculated:

$$i_{N, \text{diode}}^2 = t_B \left[\frac{4kTB}{R_s + R_B} \right] \quad (10)$$

t_B is defined in equation (8).

The amplifier component can be measured or calculated from specifications. Conversion efficiency and noise prop-

erties combine to describe sensitivity. Tangential signal sensitivity, P_{TSS} , is the RF power level at which the signal-to-noise ratio is approximately 2.5, and since the conversion efficiency describes the signal current,

$$2.5 = \frac{i_s}{i_N} = \frac{\beta_c P_{TSS}}{i_N} \quad (11)$$

Rearranging the expression and substituting (1) gives:

$$P_{TSS} = \frac{2.5 i_N}{\beta_c} \quad (12)$$

$$= \frac{5 i_N}{\beta} \underbrace{\left[1 + \frac{R_s}{R_B} \right]}_{P_{TSS0}} \underbrace{\left[1 + \left(\frac{f}{f_c} \right)^2 \right]}_{\text{Frequency Correction Factor}}$$

A detailed analysis* of P_{TSS0} yields the results presented in Fig. 3 as a function of bias current, for the amplifier conditions described. Notice that P_{TSS0} increases for increasing bias current while the frequency correction factor, Fig. 4, decreases. This means that at a particular RF frequency there exists an optimum bias current. It can be shown* that this optimum occurs when the *positive slope* of P_{TSS0} matches the *negative slope* of the frequency factor. In Fig. 5 these *slopes* are plotted so the

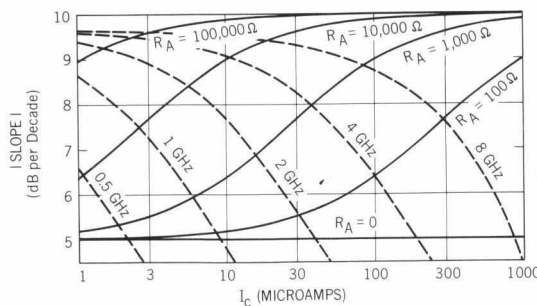

Fig. 5. Plot of slopes of low-frequency tangential signal sensitivity and of frequency response correction factor for typical *hpa* 2350 series diodes. Slope intersection defines optimum value of bias I_c for given operating frequency f and equivalent noise resistance R_A .

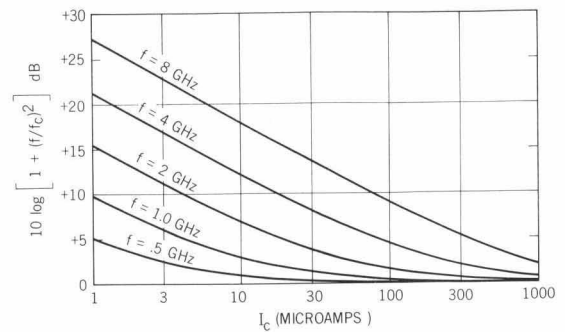

Fig. 4. Variation of tangential sensitivity frequency response correction factor vs. bias current for typical *hpa* 2350 series diodes.

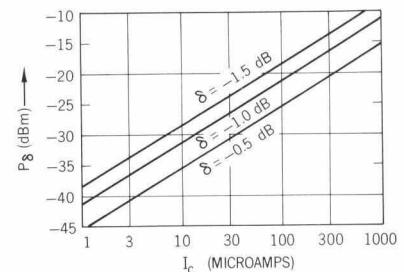

Fig. 6. Upper limit of square-law detection range as a function of bias current for a given square-law error, δ .

intersections occur at the optimum bias for a particular amplifier and a particular RF frequency, while the ordinate scale describes the sensitivity penalty for deviation from optimum bias.

The curves, Figs. 3, 4, and 5, give values directly for a 100 kHz bandwidth, for which flicker noise can be ignored. The expression in Fig. 3 for R_A takes account of flicker noise.

SQUARE-LAW RANGE

Another design consideration is that of square-law range. The lower limit of the square-law range is P_{TSS} (Figs. 3 and 4) while the upper limit is given in Fig. 6 as a function of bias current. Ordinarily, the bias current for broad square-law will be much higher than that for optimum P_{TSS} . A designer may therefore seek a compromise, unless square-law range takes precedence, in which case the *lowest* bias current giv-

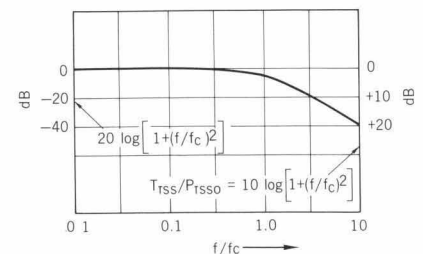

Fig. 7. Normalized frequency response for tangential signal power P_{TSS} and detected signal current.

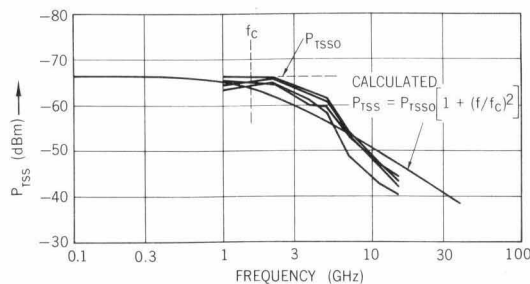

Fig. 8. Measured frequency response of typical hpa 2350 series diodes for tangential signal power P_{TSS} . Measured at $27 \mu A$ bias with $10^7 - 5$ Hz video bandwidth.

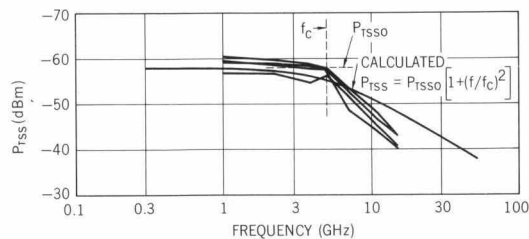

Fig. 9. Same as Fig. 8 except measurements made at bias current of $300 \mu A$. Figs. 8 and 9 demonstrate close correspondence of the diodes' measured performance to theoretical performance.

ing the required square-law range should be chosen.

At a selected bias current, the frequency response will always have the same shape. A normalized frequency response curve is given in Fig. 7. Using this shape and values of P_{TSS} and f_c from Figs. 1, 3, and 4, the curves of Figs. 8 and 9 were constructed for comparison with measured values. Deviations are attributed to losses in tuning and measurement errors. Diodes were selected to represent the spread of $-hpa-$ 2350-series characteristics.

NEW STANDARD BROADCAST FREQUENCY OFFSET FOR 1966

For the past two years, the frequencies of most standards broadcast stations have been offset -150 parts in 10^{10} with respect to national frequency standards to enable the broadcast 1-second time intervals to approximate the 1-second intervals of the UT2 time scale. Because of an imperceptible slowing of the earth's rotation, the UT2 second is lengthening. Hence, the offset for 1966, determined by the Bureau International de l'Heure, under the International Astronomical Union, will be -300 parts in 10^{10} . Accordingly, the frequencies of National Bureau of Standards HF stations WWV and WWVH and VLF station WWVL will be offset by this amount from the United States Frequency Standard during 1966.

The carrier frequency of NBS standard broadcast radio station WWVB will not be changed since it is maintained without offset from its nominal value of 60 kHz with respect to the U. S. Frequency Standard.¹

TIME PULSE ADJUSTMENTS

In accordance with the policy of maintaining the time pulses emitted by WWVB within 100 ms of the UT2 time scale, the phase of the WWVB time pulses is to be retarded 200 ms on Dec. 1, 1965, at 0000 hours UT (7:00 pm EST Nov. 30). The phases of time pulses from WWV and WWVH will not be changed on Dec. 1, 1965.

¹ "Atomic Time Adopted for WWVB," *Hewlett-Packard Journal*, Vol. 16, No. 6, Feb., 1965.

HOT CARRIER DIODE CHARACTERISTICS

hpa Type	SSB Noise Figure NF _o (dB)	Noise Figure Match ΔNF (dB)	IF Impedance Z _{IF} (ohms)	IF Impedance Match ΔZ _{IF} (ohms)	RF Impedance (VSWR)	Package	Remarks
2350	7	—	150–200	—	1.5	Min. Glass	
2351	7	0.3	150–200	25	1.5	Min. Glass	Matched Pair
2353	7	—	150–200	—	1.5	Cartridge	
2354	7	0.3	150–200	25	1.5	Cartridge	Matched Pair
2365	6.5	—	150–200	—	1.3	Min. Glass	
2366	6.5	—	150–200	—	1.3	Cartridge	
2367	7	—	—	—	1.5	Min. Glass	Hi-Reliability Spec.
2369	6.5	—	—	—	1.3	—	Hi-Reliability Spec.
2374	7.0	0.3	150–200	25	1.5	Min. Glass	Matched Quad

For all diodes above, $R_s = 12 \Omega \pm 6 \Omega$, $C_0 = 0.75 \text{ pF} \pm 0.25 \text{ pF}$
^o For NF test, RF = 2 GHz, IF = 30 MHz, LO drive = 1 mW

Although their mixer and detector applications have been presented in detail, this should not be interpreted to mean that these are the only fruitful areas of application for hot carrier diodes. As high-speed switches, hot carrier diodes offer the possibility of gaining an order of magnitude in switching speed. Furthermore, the low level of minority carrier density reduces the drive requirements. In the area of high-speed switching, a discussion of their characteristics in specific types of switching applications is beyond the scope of this article. Suffice it to say that their characteristics of leakage and breakdown voltage are comparable to that of available high-speed P-N junction devices.

ACKNOWLEDGMENT

The author gratefully acknowledges the technical advice of Paul Sedlewicz, research physicist at *hp Associates*.

—Hans O. Sorensen

REPRINTS AVAILABLE

The two feature articles on detection and mixing with hot carrier diodes in this issue are condensations of the authors' original papers. Copies of the originals are obtainable on request from *hp associates*, 620 Page Mill Road, Palo Alto, Calif. 94304

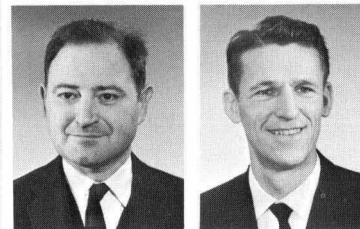

Milton Crane Hans O. Sorensen

Milton Crane

Milt Crane joined $-hp-$ Associates in 1964 to work on microwave devices and components. For 10 years prior to that time, he had been concerned with microwave systems and devices at a university research laboratory. He is presently investigating RF circuitry in the $-hp-$ Advanced Research and Development Laboratories.

Milt obtained a BSEE from California Polytechnic College in 1951 and an MSEE from Stanford University in 1953.

Hans O. Sorensen

Hans Sorensen joined $-hp-$ in 1958 immediately following graduation from the Illinois Institute of Technology with a BSEE degree. Initially, he worked on high-frequency voltmeters, after which he joined the Research and Development Applications Group of $-hp-$ Associates in 1963 where he has been investigating applications of hot carrier diodes, p-i-n diodes, and opto-electronic devices.

Hans obtained his MSEE degree in 1960 from Stanford University in the $-hp-$ Honors Cooperative Program.

USING THE HOT CARRIER DIODE AS A MICROWAVE MIXER

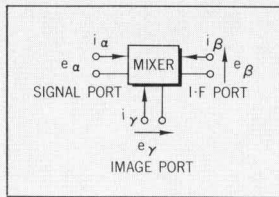

Fig. 1. Representation of mixer as 3-port linear network.

In high-frequency mixer applications the hot carrier diode is attractive to designers because it has a number of advantages over the point contact diode usually used. For example:

1. The I-V characteristic relationship of the hot carrier diode is more nearly that of a perfect diode. The diode equation:

$$I = I_s \left(e^{\frac{q}{nkT} V} - 1 \right)$$

is ideal when $n = 1$. The value of n for the hot carrier diodes is less than 1.08, whereas the lowest value of n for the point contact is rarely less than 1.3. The more nearly ideal the diode I-V relationship (the lower the n), the greater the conversion efficiency at the barrier at any specified local oscillator drive.

2. The hot carrier diode is almost a perfect majority carrier device.* Its upper frequency limit is not dependent on minority carriers. In switching applications the diode's switching speed is not limited by minority-carrier storage effects.
3. The higher breakdown voltage of the hot carrier diode (> 15 volts) allows for higher local oscillator drive with little increase in overall noise figure. This means that the dynamic range can be increased and the intermodulation distortion decreased with little loss of signal sensitivity.
4. The flicker or $1/f$ noise is lower by more than 30 dB, making the diode ideal as a zero i-f doppler radar mixer. The reduction in $1/f$ noise is due to the surface treatment between the metal-to-semiconductor junction and the simple planar geometry of the junction.

* Bonded point contact diodes contain a p-n region around the whisker.

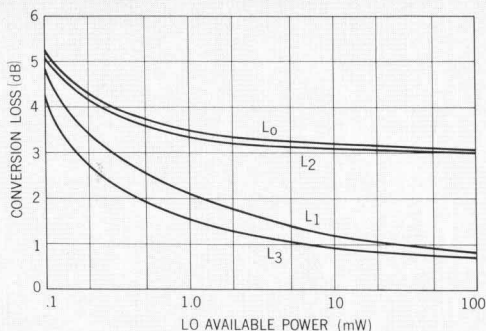

Fig. 2. Calculated conversion loss vs. local oscillator available power for hpa 2350 series hot carrier diodes (parasitic losses neglected).

5. Shot noise (the main contributor to the noise temperature ratio at higher i-f frequencies) is lower. This is believed to be due to the reduced diffusion of minority carriers. At a 30 MHz (Mc/s) i-f, the measured noise temperature ratio is less than 1.0 and typically 0.9.
6. The burn-out energy is higher than that of the point contact when designed to operate at the same frequency.
7. The characteristics of the hot carrier diode are more reproducible in production and have tighter specifications and higher reliability than the point contact because of the planar surface barrier utilizing epitaxial silicon technology.

MIXER CONVERSION LOSS AND NOISE FIGURE

This paper is concerned with the use of the hot carrier diode in microwave mixing applications, mixing being defined as the frequency conversion or translation of a signal from its microwave frequency to a lower IF frequency. In the process of mixing there are a loss of signal and an increase of noise. These two important factors are discussed in the following. This discussion is then concluded with a section giving measured data on the hot carrier diode as a mixer.

MIXER CONVERSION LOSS

The three-port linear network (Fig. 1) usually used to represent a microwave mixer can be reduced to a two-port linear network by terminating the image port. The image port can be arbitrarily terminated in any impedance, but the three most important possibilities are where the image is terminated (a) in a short circuit, (b) at the same impedance as the signal, and (c) in an open circuit. These three conditions of image termination will be referred to as L_1 , L_2 , and L_3 following the notation of Torrey and Whitmer.¹

¹ Crystal Rectifiers, MIT Rad. Lab., Vol. 15, by H. C. Torrey and C. A. Whitmer.

Plotted in Fig. 2 are calculated curves for image termination designated as L_0 , L_1 , L_2 , and L_3 , for the typical $-hpa-$ 2350 hot carrier diode. The L_0 condition is closely related to L_2 since both are broadband conditions with the image and signal at the same impedance. For L_0 the LO power is matched for minimum VSWR whereas L_2 has the signal-image matched for minimum conversion loss. The difference in conversion loss between L_0 and L_2 is slight, as indicated on the graph of Fig. 2.

The equivalent circuit of the simple mixer is shown in Fig. 3.

The conversion loss plotted in Fig. 2 is the loss resulting from the barrier admittance matrix (conversion efficiency) and does not take into consideration the loss due to the diode's time-invariant parasitic elements. The schematic diagram of the mixer diode as shown in Fig. 4 includes L_p , C_p , R_s , and C_b which form the parasitic elements. The barrier admittance matrix is $g(t)$.

The series inductance L_p and the shunt capacitance C_p of the package or cartridge of the diode can often be incorporated into the microwave filters or matching circuits of the mixer. The package elements plus the C_b barrier capacitance and R_s series resistance are the factors that limit the bandwidth of the mixer. The elements L_p and C_p are the package limitations on the mixer performance. These limitations can, of course, be reduced by selecting cartridges that have low values of L_p and C_p .

The fundamental limitation on the conversion loss is the series resistance

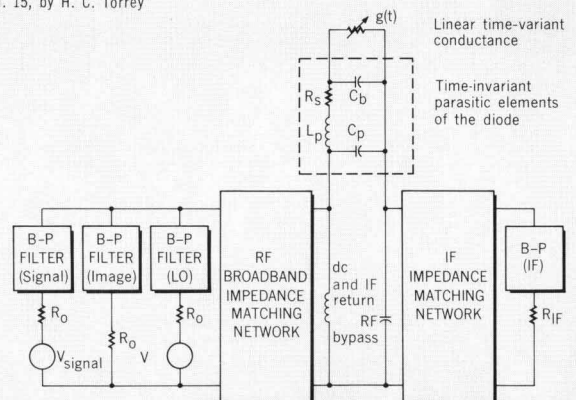

Fig. 3. Equivalent circuit of an ideal simple broadband mixer.

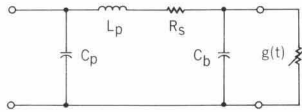

Fig. 4. Schematic diagram of hot carrier diode.

(spreading resistance) and the barrier capacitance. The product of R_s and C_b depends on the electrical properties of the semiconductor metal at the junction, the geometry of the junction and the barrier voltage. The $R_s C_b$ product has been reduced in the hot carrier diode by the geometry of the metal-to-semiconductor interface and the use of a thin epitaxial semiconductor layer.

Consider the package elements as part of the impedance matching network and R_s and C_b as part of an RC network in the signal port. The loss of signal to the dynamic barrier conductance can then be calculated. The efficiency of conversion of the barrier conductance is assumed to be unchanged by the RC network of Fig. 5. The ratio of power delivered to the barrier signal resistance R_{bs} to the available power is noted in Equation (1).

$$\frac{P_b}{P_a} = \frac{1}{1 + \omega^2 C_b^2 R_{bs} + R_s/R_{bs}} \quad (1)$$

where P_b = power to the barrier resistance R_{bs}
 P_a = available power signal.

The loss of power to the barrier resistance can be computed as a function of R_{bs} for a given diode. The calculation of R_{bs} is difficult because of the problem of finding the LO voltage waveform across the barrier. The minimum loss for equation 1 can be found and occurs when $R_{bs} = 1/\omega C_b$, and is given in Equation (2):

$$L_{min} = 1 + 2\omega C_b R_s \quad (2)$$

Minimum loss for the *-hpa-* 2350 Hot Carrier Diode occurs at an LO

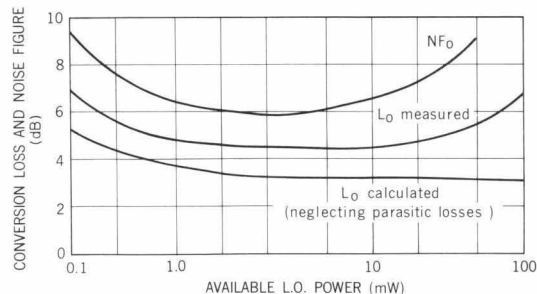

Fig. 6. Conversion loss (L_0) and noise figure (NF_0) for typical *hpa* 2350 series diodes vs. LO available power. $f_0 = 2$ GHz, $IF = 30$ MHz, $NF_{IF} = 1.5$ dB.

available power in the range of 1.0 to 2.0 mW. The calculated minimum loss of power to the barrier of this diode is approximately 1.0 dB at 2.0 GHz. The R_{bs} (and hence the loss) changes slowly with LO drive because of the self-bias of the diode. The self-bias voltage developed across the series resistance tends to oppose the decrease in barrier resistance as the LO drive power is increased. As the LO drive decreases, the barrier capacitance reduces the signal at the barrier admittance. The same decrease of signal occurs with increasing drive due to the series resistance. The conversion loss due to the barrier admittance decreases monotonically with increasing LO drive, which is shown by the curve of L_0 calculated in Fig. 6. However, the plot of the measured value L_0 contains a combination effect of the barrier conversion efficiency and the parasitic loss. The third curve is the measured Noise Figure and was included to show that the noise temperature ratio is also a slowly-increasing function of LO drive. This Noise Figure is slightly greater than the increase due to the conversion loss and i-f figure.

If the diode is operated at low frequencies (UHF or lower), the parasitic losses can be minimized by using lower LO drive. However, even with impedance-matching of the r-f and i-f signals, the conversion loss would increase when the point is reached where the decrease in parasitic loss is matched by the decrease in conversion efficiency. Hence the minimum conversion loss is always a compromise between parasitic losses and conversion efficiency of the barrier.

MIXER NOISE FIGURE

The noise figure rating is probably the most important specification on the mixer diode. The noise figure is the ratio of actual mixer output available noise power within the i-f band-

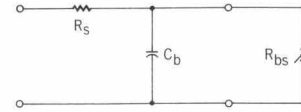

Fig. 5. RC network including parasitic elements of hot carrier diode.

width to the thermal power within the same i-f bandwidth. For the mixer diode this ratio is equal to the conversion loss ratio times the noise temperature ratio.

The noise figure most often listed on the data sheet is a receiver noise figure. This is a measurement taken with an i-f amplifier that simulates an overall broadband receiver noise figure measurement. This noise figure, NF_0 (ratio), is noted in the following equation:

$$NF_0 = L_0 (t_x + NF_{IF} - 1) \quad (3)$$

L_0 is the broadband conversion loss (ratio) including the loss due to the parasitic elements,

t_x is the noise temperature ratio,

NF_{IF} is the noise figure ratio of the i-f amplifier.

The definition of receiver noise figure as summarized in Equation (3) is more complicated than it seems. This is because the noise temperature ratio t_x is not independent of the conversion loss² as noted in Equation 4 for the broadband case.

$$t_x = \bar{t} \left(1 - \frac{2}{L_0}\right) + \frac{2}{L_0} \quad (4)$$

\bar{t} is an average noise temperature obtained by averaging the instantaneous

² G. C. Messenger and C. T. McCoy, Theory and Operation of Crystal Diodes as Mixers, Proc. IRE, Sept., 1957, p. 1269.

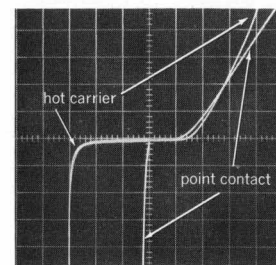

Fig. 7. Double-exposure oscillogram comparing I-V characteristics of typical *hpa* 2350 series diode and point contact diode. Hot carrier diode has steeper forward curve and higher reverse resistance. For forward curves, vertical = 20 mA/div, Horizontal = 0.2 V/div; for reverse, vertical = 10 V/div, horizontal = 10 μ A/div.

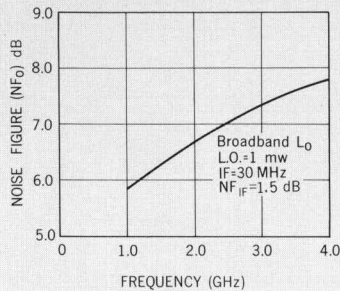

Fig. 8. Noise figure (NF_0) vs. frequency for typical hpa 2350 series diode. Broadband L_0 test conditions with $LO = 1$ mW, $IF = 30$ MHz, $NF_{IF} = 1.5$ dB.

noise from the crystal as the LO voltage varies over a cycle. If the LO voltage source is also noisy, this adds to \bar{t} . In balanced mixers the LO noise can be greatly reduced by cancelling techniques. The value of \bar{t} goes to $\frac{1}{2}$ in the limit when the noise is only shot noise. At an i-f of 30 MHz, t_x has been measured as low as 0.8 with $L_0 = 4$, which calculates to a $\bar{t} = 0.6$. The reason for the low value of \bar{t} and hence t_x for the hot carrier diode is the high breakdown voltage in the back direction. The noise generated when the LO voltage swings in the back voltage direction is negligible even under high LO drive. The I-V curves of the hot carrier diode and a point contact diode are shown in Fig. 7. In Fig. 7, the back voltage breakdown is shown. The back current resulting from this breakdown is extremely noisy; hence, when the LO voltage swings into this region, \bar{t} is greatly increased. If the conversion becomes ideal ($L_0 = 2$), there is no loss of signal within the mixer; the signal power is completely converted to the i-f and image. This means that noise cannot be added in the conversion process because conversion is nondissipating. Hence as the conversion efficiency goes to unity \bar{t} becomes less important. In practical mixers where the

Test Frequency ⁽¹⁾	RF Input 2.0 GHz	i-f Output 30 MHz
	Maximum	Typical
Receiver Noise Figure (NF_0) ⁽²⁾ ($NF_{IF} = 1.5$ dB)	7.0 dB max	6.5 dB
Conversion Loss (L_0)	5.5 dB max	5.0 dB
Noise temperature ratio (t)	1.0 max	
IF Impedance ⁽³⁾	150 to 250 ohms	175 ohms
RF Impedance (VSWR)	1.5 max	1.3
Temperature -50°C to 100°C	$\frac{\Delta NF_0}{\Delta T} = .004$ dB/ $^\circ\text{C}$ typical	
Burnout	5 ergs minimum	

(1) All tests were made in the -hpa- 806A primary standard test holder with a LO available power of 1.0 mW and a $R_s = 1$ ohm, d.c. ground return. The i-f amplifier has a noise figure of 1.5 dB at 30 MHz. The diode was tested under broadband L_0 conditions.

(2) The noise figure is a single sideband receiver noise figure. The argon discharge tube used in the noise figure meter was corrected to an excess noise of 15.7 dB as reported by National Bureau of Standards.

(3) IF impedance was measured at 30 MHz.

$L_0 > 3$, the average noise temperature ratio greatly affects t_x and thus the overall noise figure of the mixer.

MEASUREMENTS OF THE HOT CARRIER DIODE AS A MICROWAVE MIXER

The hot carrier diode is similar to the point contact diode in theory and operation. Hence, the measurements or characterization of the diode are the same as for the point contact diode and any departures will be noted in this section. Test procedures and theory of measurement of microwave mixers are well documented.

The first and simplest measurement is the I-V curve of the diode. Fig. 7 shows the curves for the hot carrier diode -hpa- 2350 and a typical point contact diode. The higher breakdown voltage and the greater nonlinearity in the forward direction of the hot carrier diode as compared to the point contact diode is typical.

Microwave mixer diodes are tested in holders which become an important consideration in the measurement. In order to assure a standardization, primary standard mixer holders are specified by the Armed Services Electro-Standard Agency. The purpose of these holders is to assure that the diodes are tested under the same condition of image termination. The image is terminated for broadband L_0 conditions. The -hpa- 2350 is in a miniature glass package, which requires a different primary standard holder. Such a coaxial holder has been designed and built to test -hpa- hot carrier diodes. The holder, -hpa- 806A, is adjusted for broadband L_0 conditions. Microwave tests performed on the diode in this holder are equivalent to point contact diode tests in the JAN primary test holder. The use of an -hpa- primary test holder is the only major departure from MIL-STD-750. Test procedures used in evaluating are listed in MIL-STD-750 in Section 4100.

Besides the tests listed in MIL-STD-750, measurements, as shown in Figs. 8, 9 and 10, have also been made to assist in application engineering. Fig. 8 is a plot of Noise Figure (NF_0) vs. frequency. The LO available power was 1.0 mW. Fig. 9 is a plot of Noise Figure (NF_0) vs. available LO power. This plot is of particular interest to receiver designers because of the effect of high LO drive. The dynamic range of the

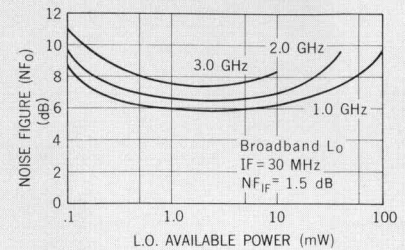

Fig. 9. Noise figure vs. LO available power for a typical hpa 2350 series diode. Broadband L_0 , $IF = 30$ MHz, $NF_{IF} = 1.5$ dB.

mixer can be increased one or two orders of magnitude with little increase in noise figure. This points out the low internal noise generation of the hot carrier diode under high LO drive.

Figure 10 is a plot of i-f impedance vs. LO available power. The impedance is almost purely resistive because the reactances of the parasitic elements are negligible. The low-noise i-f amplifiers are also sensitive with respect to source impedance. Care should be given to matching the mixer's i-f impedance to the input impedance of the i-f amplifier to obtain the lowest overall noise figure.

CONCLUSIONS

The hot carrier diodes make excellent mixers as shown by the measurements of these diodes presented in this article. The theory and operation of the hot carrier diodes are similar to the point contact diodes. The diodes are, however, not directly interchangeable. The parasitic elements, mainly the barrier capacitance, are different, thus requiring different operating conditions of LO drive and impedance levels.

Improvements in cartridge design, reductions in the series resistance and the barrier capacitance are resulting in high performance hot carrier mixer diodes with frequency limitations to above X-Band.

—Milton Crane

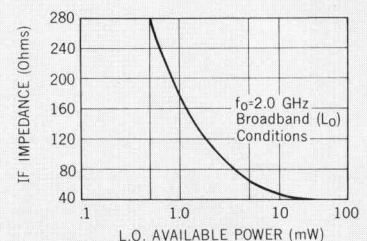

Fig. 10. IF impedance vs. LO available power for typical hpa 2350 series diode. $IF = 30$ MHz, $f_0 = 2.0$ GHz, broadband L_0 test conditions.